



Memory of  
*an authentic celebration*





**201292 JASMINE**

3D  
H 1,70 x Ø 1,15 m  
14 Kg - 128 W

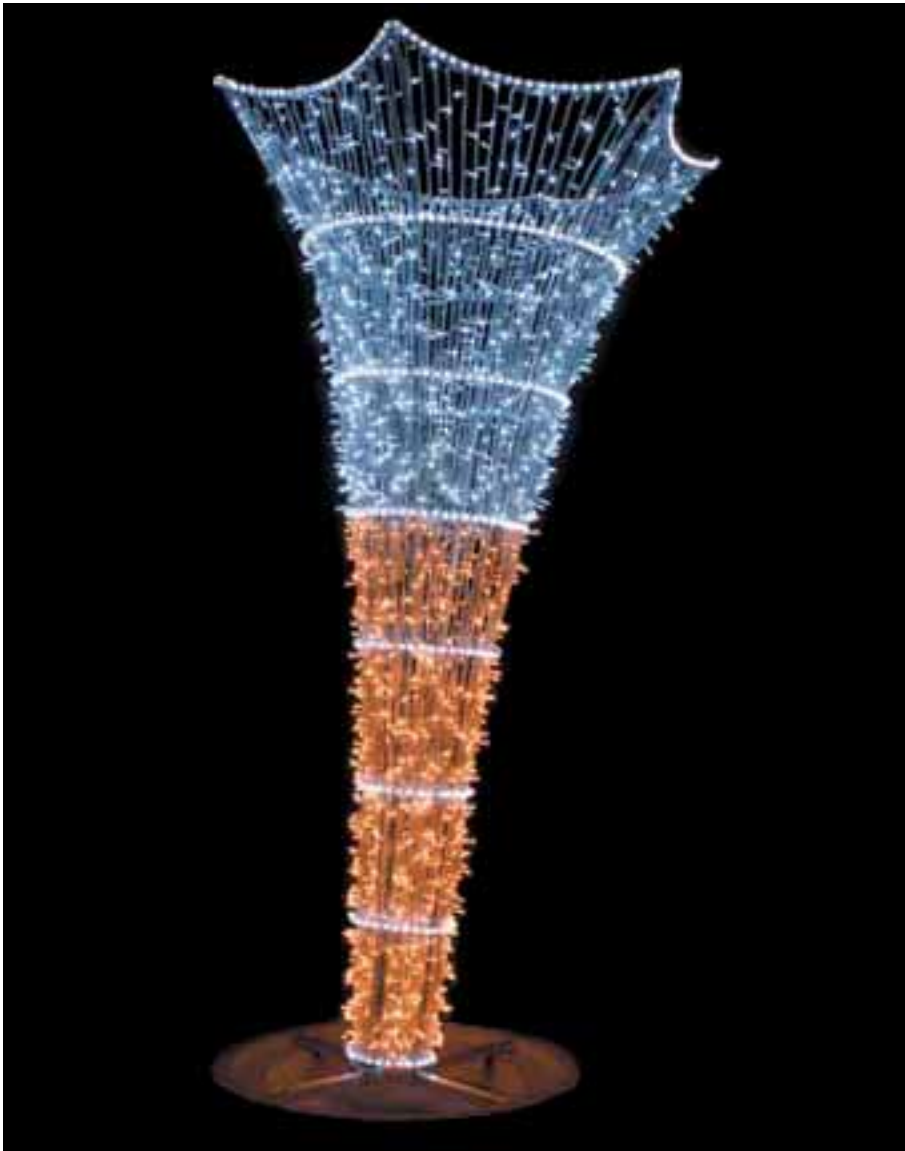

**201293 CIRCUS**

Floor standing 3D  
H 2,55 x Ø 1,35 m  
29 Kg - 208 W



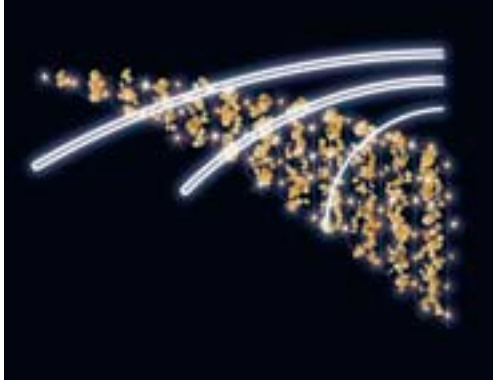

**201573\*** DELPHES

H 1 x W 1,50 m  
9 Kg - 24 W

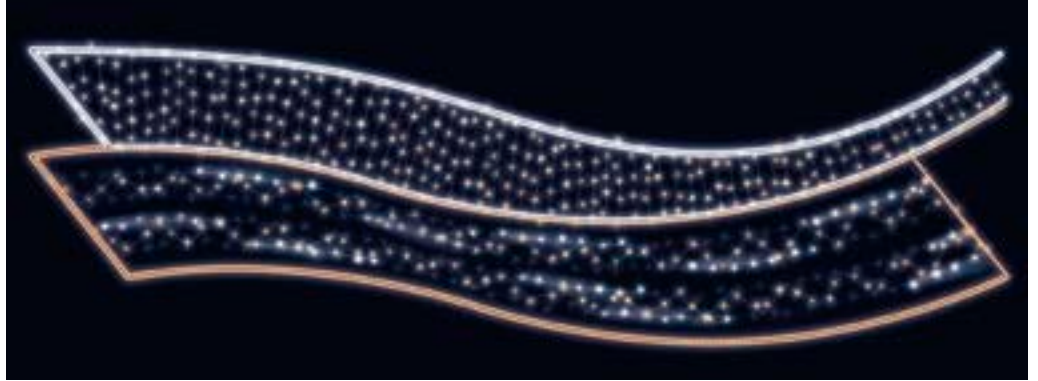

**201571\*** RUBAN SCINTILLANT

Animated by running effect garland  
H 1,50 x W 5 m  
30 Kg - 146 W

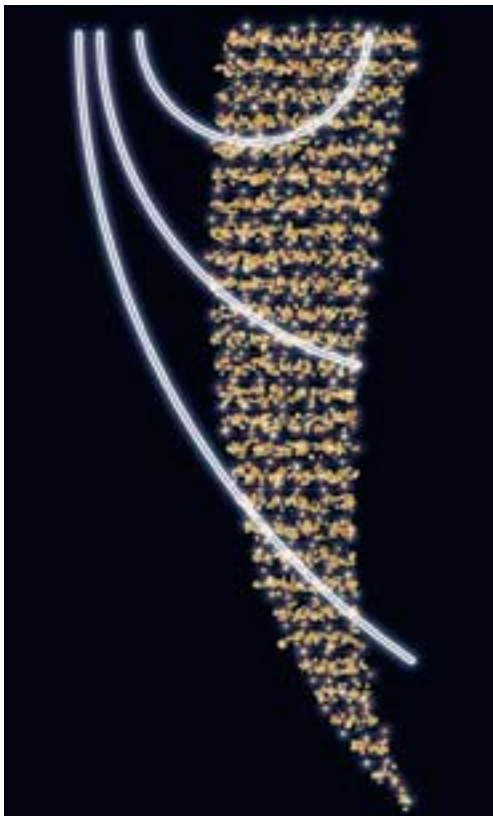

**201572\*** ORACLE

H 3,50 x W 1,50 m  
21 Kg - 65 W





**201342 ÉVENTAIL**

3D, animated  
H 2,30 x W 2,45 x D 2,70 m  
45 Kg - 220 W



Éventail | Clermont-Ferrand 2009



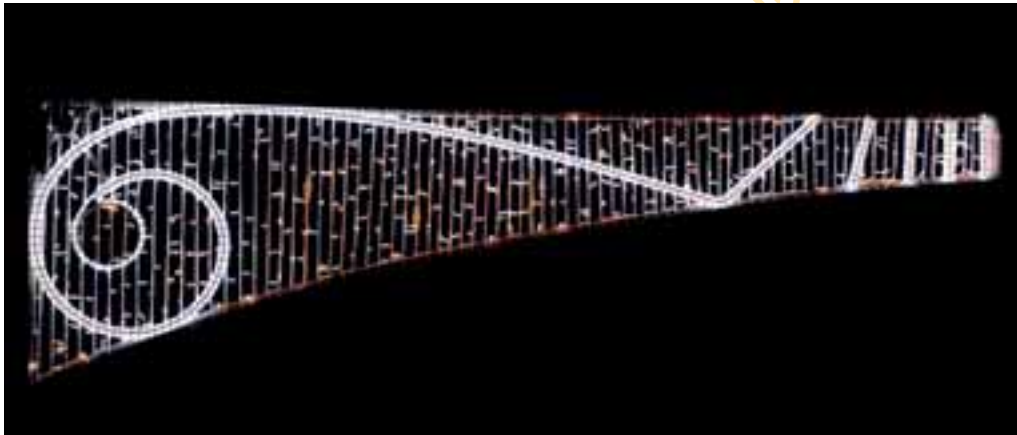

**201268 ANDALOUSIE OR**

H 1,10 x W 3,65 m  
13 Kg - 72 W

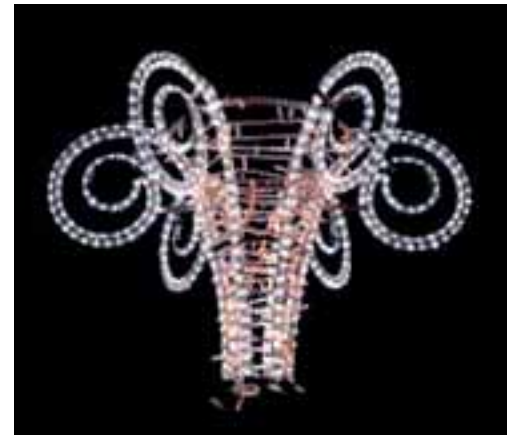

**201270 FLAMENCO OR**

3D  
H 0,60 x Ø 0,95 m  
8 Kg - 70 W



**201280 YSIS**

H 1 x W 3,25 m  
10 Kg - 47 W



**201314 PETIT YSIS**

H 1 x W 1,15 m  
4 Kg - 20 W



Ysis & Lisy | Arcachon 2009



**201281 LISY**

3D  
H 1,55 x Ø 1,10 m  
13 Kg - 82 W



**201428 FLOCONS FILANTS**

Animated by Satilight

H 1 x W 3 m

10 Kg - 34 W + 4 sockets (15 W maxi)



**201574\* FLOCONS RAYONNANTS**

Animated by Satilight

H 3 x W 1 m

11 Kg - 39 W + 2 sockets (15 W maxi)





### 201429 MONT D'OR

Animated by flash bulbs  
H 1,10 x W 3 m  
17 Kg - 67 W + 9 sockets (15 W maxi)



### 201430 COLLINE D'OR

Animated by flash bulbs  
H 3 x W 1 m  
12 Kg - 51 W + 6 sockets (15 W maxi)



### 201431 PETITE COLLINE D'OR

Animated by flash bulbs  
H 1 x W 1 m  
5 Kg - 15 W + 3 sockets (15 W maxi)



 Interactivity p.121



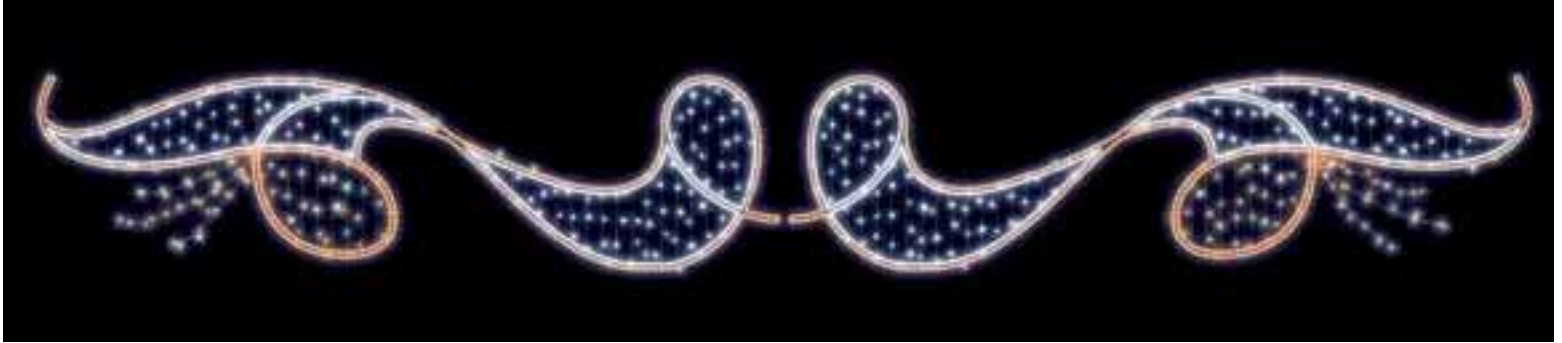

**201487 ELENA**

H 0,80 x W 6 m  
26 Kg - 122 W



**201087 JOYEUSES FÊTES DYNAMIQUES**

H 1,10 x W 4 m  
28 Kg - 150 W  
English version : «Greetings» (ref.201240)

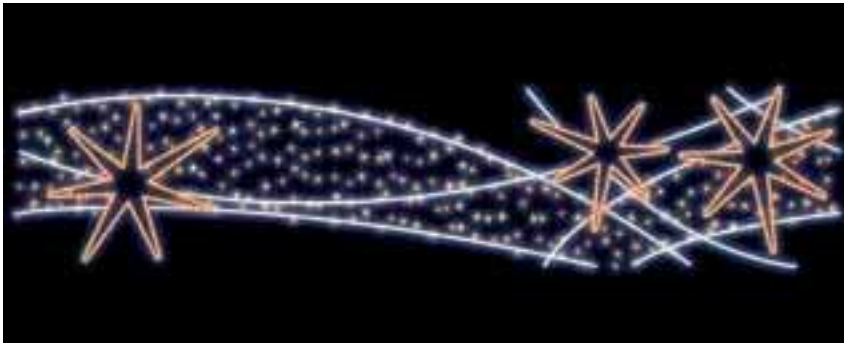

**201180 COURANT D'AIR LED**

H 0,80 x W 3,50 m  
18 Kg - 165 W





**201492 PETITE ELENA**

H 1 x W 1 m  
5 Kg - 19 W



**201182 BOL D'AIR**

H 1,60 x W 0,70 m  
8 Kg - 125 W



**201181 BRISE**

H 1,20 x W 0,70 m  
6 Kg - 55 W



**201512 ISIDA**

Animated by flash bulbs  
H 2 x W 0,90 m  
8 Kg - 25 W + 3 sockets (15 W maxi)



**201106** JOYEUSES FÊTES PÉTILLANT

H 1,10 x W 6 m

35 Kg - 180 W

English version : «Happy New Year» (ref.201234)



**201203** BOULE MAGIQUE LED ROUGE

3D

Ø 0,55 m

8 Kg - 70 W



**201343** SPHÈRE PAILLETÉE

3D

Ø 0,65 m

4 Kg - 20 W





**201575\*** ESQUISSE

H 3 x W 1 m  
14 Kg - 65 W

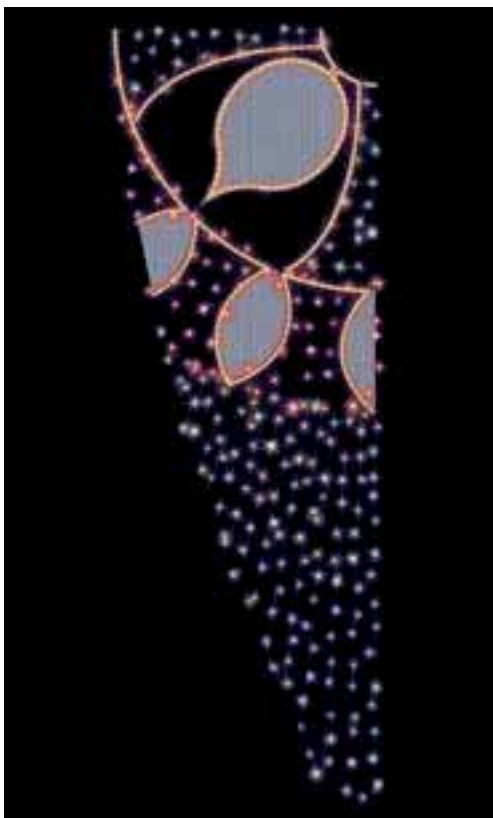

**201576\*** PASTEL

H 3 x W 1 m  
12 Kg - 51 W





**201089 MEILLEURS VŒUX**

H 1,30 x W 6 m

36 Kg - 165 W

English version : «Best wishes» (ref.201238)



**200503 BONNE ANNÉE SCINTILLANTE**

Animated by garland & flash bulbs

H 1,30 x W 6 m

35 Kg - 185 W + 4 sockets (15 W maxi)

English version : «Happy New Year» (ref.200566)



**201323 ARCHE GLACÉE**

Animated by flash bulbs

H 1,80 x W 3,50 m

29 Kg - 120 W + 4 sockets (15 W maxi)

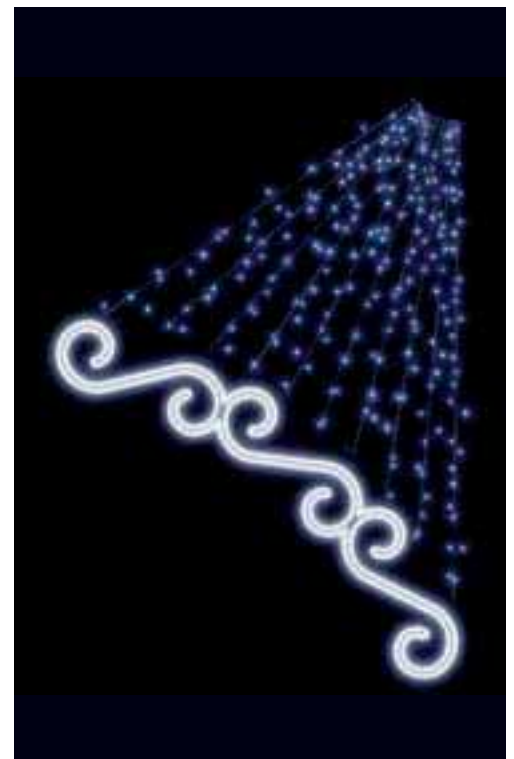

**201212 GALOPADE**

H 2 x W 1,25 m

7 Kg - 55 W



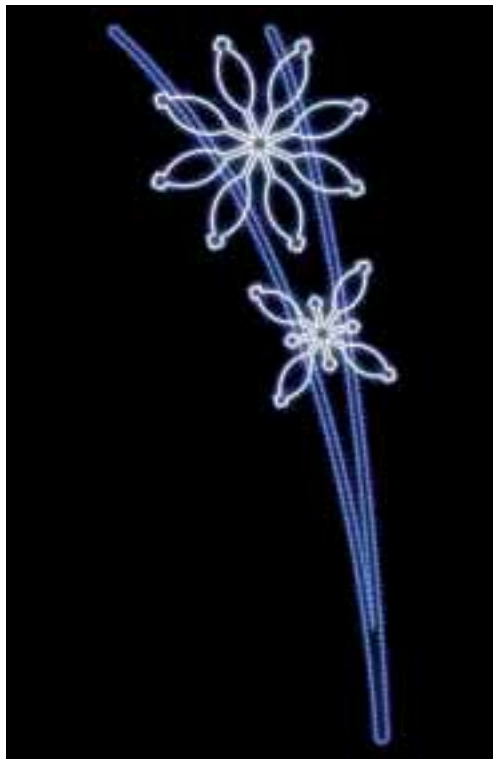

**201321 GRAND AURO**

H 3 x W 1,20 m  
13 Kg - 55 W

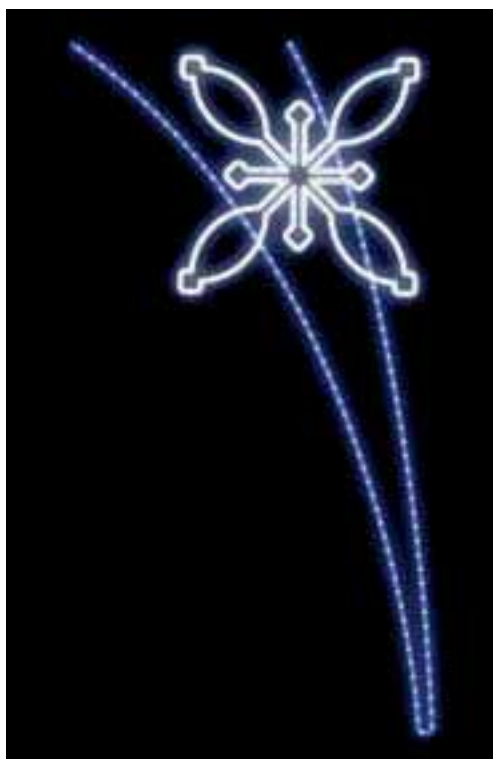

**201322 AURO**

H 1,50 x W 0,80 m  
7 Kg - 20 W

Double Arche glacée & Grand Auro | Levallois 2009





**201137 CRÉPUSCULE**

3D suspension not included (ref. 201229)  
H 1 x W 6 m  
32 Kg - 180 W



**201139 JOYAU**

3D suspension not included (ref. 201229)  
H 0,90 x W 6 m  
19 Kg - 120 W



**201138 PETIT JOYAU**

3D suspension not included (ref. 201229)  
H 2 x W 1,10 m  
7 Kg - 35 W



**201147 ECHOSPHERE**

3D  
Ø 0,55 m  
8 Kg - 45 W



**201229 BIJOU**

3D  
Ø 0,55 m  
7 Kg - 60 W



**201586\*** SPHÈRE SCINTILLANTE

3D, animated by auto scintillating garland  
Ø 0,55 m  
3 Kg - 19 W



**201511** GRANDE BOULE MAGIQUE

3D  
Ø 1 m  
13 Kg - 30 W



**201202** BOULE MAGIQUE LED BLANCHE

3D  
Ø 0,55 m  
8 Kg - 70 W



Boules magiques spécifiques | Levallois 2009





**201507 PÉPITE**

Animated by garland. Fixed version ref. 201516  
H 0,90 x W 5 m  
23 Kg - 80 W



**201432 NUIT DES ÉTOILES**

Animated by garland. Fixed version ref. 201517  
H 0,70 x W 6 m  
36 Kg - 82 W





**201506 PÉPITA**

Animated by garland. Fixed version ref. **201518**  
H 2 x W 0,95 m  
13 Kg - 45 W



**201493 PETITE PÉPITA**

H 1 x W 1 m  
7 Kg - 23 W



**201508 GRAND CRISTAL DE LUMIÈRE**

H 1 x W 1,20 m  
6 Kg - 18 W

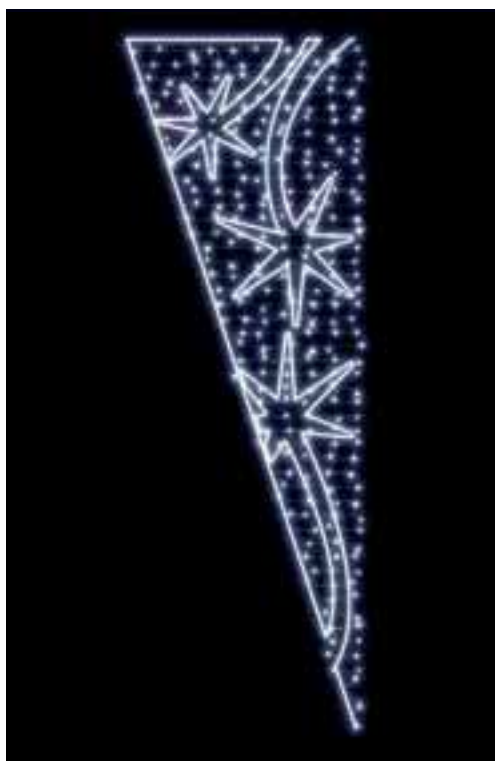

**201434 BELLE NUIT DES ÉTOILES**

Animated by garland. Fixed version ref. **201519**  
H 3 x W 1 m  
11 Kg - 38 W



**201433 PETITE NUIT DES ÉTOILES**

H 1 x W 1 m  
8 Kg - 19 W



**201509 PETIT CRISTAL DE LUMIÈRE**

H 0,70 x W 0,60 m  
3 Kg - 9 W

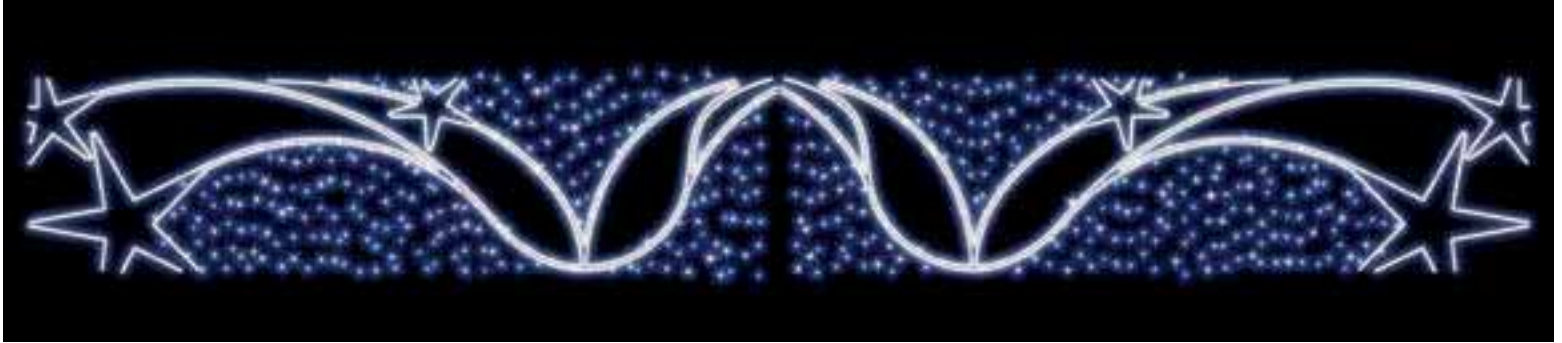

**201340 SIROCCO**

H 0,80 x W 6 m  
29 Kg - 110 W



**201341 SIERRA**

H 2 x W 0,80 m  
8 Kg - 30 W

**201351 BLEU D'ÉTOILES**

H 1,35 x W 1,45 m  
8 Kg - 25 W

**200804 BRAISE**

Animated by a flash bulb  
H 1 x W 0,85 m  
5 Kg - 16 W + 1 socket (15 W maxi)

**201196 MOBILE D'ARGENT**

3D  
Ø 0,75 m  
15 Kg - 88 W

**200723 ÉTOILE 3D BLANCHE**

3D  
H 0,65 x Ø 0,60 m  
3 Kg - 29 W

**201218 TOMBÉE D'ÉTOILES**

Animated by flash bulbs  
H 1,30 x W 1,30 m  
8 Kg - 25 W + 6 sockets (15 W maxi)



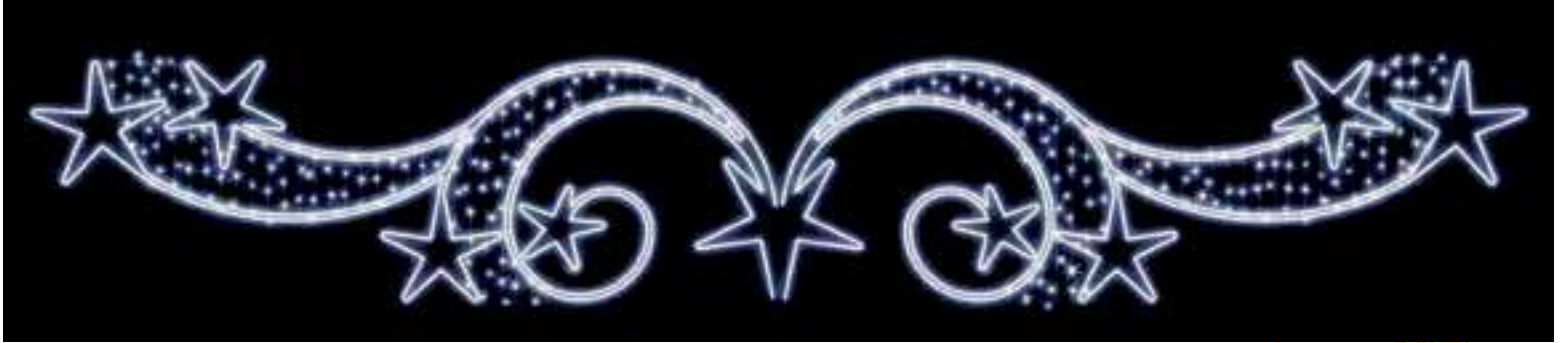

201326 HÉLIO

H 1 x W 6 m  
29 Kg - 95 W

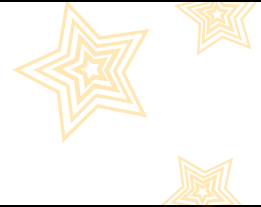



**201355 ALIOT**

H 2 x W 1 m  
8 Kg - 30 W



**200532 SAPIN ENCHANTÉ**

Animated by flash bulbs  
H 2,80 x W 2,60 m mini - Ref. for 2 sides  
20 Kg - 160 W + 14 sockets (15 W maxi)



**201167 SAPIN ENCHANTÉ**

Animated by flash bulbs  
H 1,50 x W 0,80 m - Ø inside 66 cm  
7 Kg - 30 W + 2 sockets (15 W maxi)

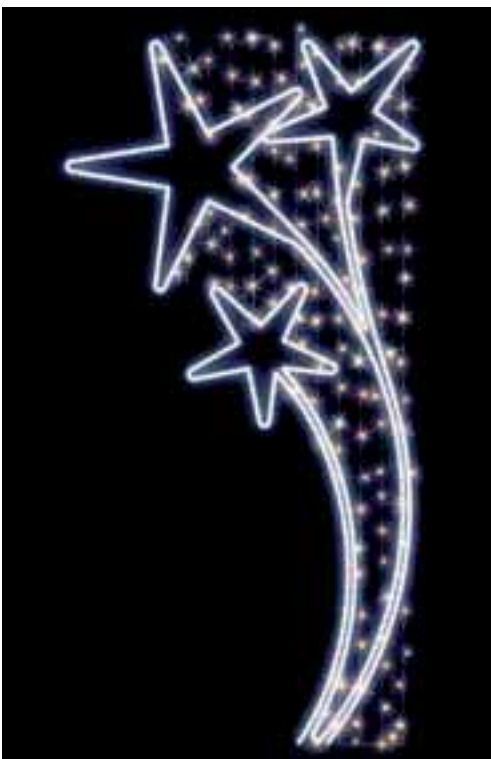

**201325 HELIMA**

H 2 x W 1 m  
9 Kg - 35 W





**200697 GIBOULÉE**

H 2 x W 0,60 m  
8 Kg - 39 W

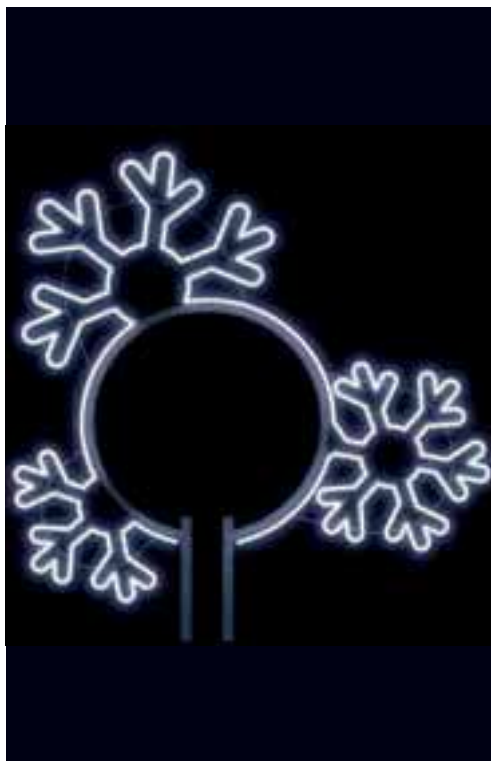

**201350 ONDE DE GLACE**

H 1,35 x W 1,45 m - Ø inside 68 cm  
8 Kg - 25 W



**200700 DIAMANTINE**

H 1,20 x W 0,80 m  
5 Kg - 29 W

**200980 JEU SOLAIRE**

Fastening in the middle  
H 1,50 x W 1,50 m  
8 Kg - 35 W

**201328 JEU DE FLOCONS**

Fastening in the middle  
H 1 x W 1,10 m  
7 Kg - 25 W

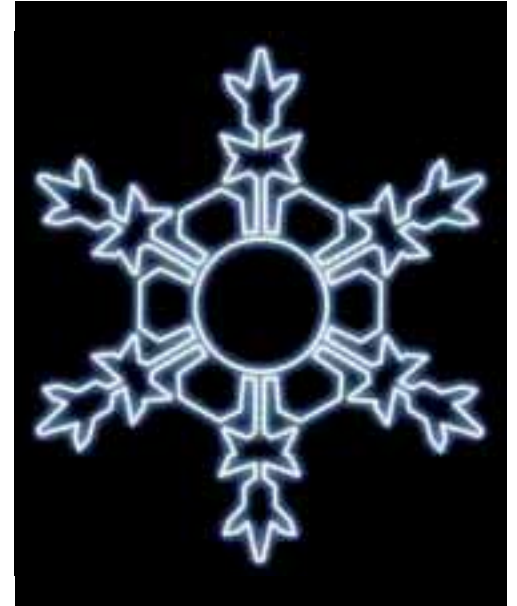
**200978 JEU DE CRISTAL**

Fastening in the middle  
H 1,50 x W 1,30 m  
10 Kg - 50 W

**200981 JEU D'ANNEAUX**

3D, fastening in the middle  
H 1,50 x W 1,50 m  
8 Kg - 35 W



Jeux d'anneaux | Arcachon 2009





**201058 ÉTOILE D'AIRAIN**

3D  
H 1,10 x W 1,10 m  
13 Kg - 28 W

**201488 ÉTOILE 2D EFFET 3D**

H 1,60 x W 1,50 m  
5 Kg - 39 W

Étoile d'airain | Strasbourg 2007





**201383 ÉTOILES POUR TRAÎNEAU**

Floor standing 3D  
H 1 x W 1,60 x D 1 m  
10 Kg - 17 W



**201348 TRAÎNEAU ENCHANTÉ**

Floor standing 3D  
H 1,90 x W 2,20 x D 1 m  
38 Kg - 134 W



**201349 MELCHIOR**

Floor standing 3D  
H 1,80 x W 1,90 x D 0,55 m  
43 Kg - 91 W



Traîneau enchanté & Melchior | Boulogne 2009





**200725 ANGE 3D**

3D to be suspended  
H 2,50 x W 1,10 x D 1,50 m  
44 Kg - 140 W



**200812 PÈRE NOËL**

Floor standing 3D  
H 3 x W 1,20 x D 0,90 m  
76 Kg - 125 W + 2 sockets (15 W maxi)



**200837 BONHOMME DE NEIGE**

Floor standing 3D  
H 2 x W 1,30 x D 1 m  
87 Kg - 55 W + 7 sockets (15 W maxi)

Otarie & Ours 3D | Puteaux 2008





Igloo & Ours 3D | Laval 2007



**200775 OURS**

Floor standing 3D  
H 1,10 x W 2 x D 0,90 m  
121 Kg - 324 W



**200779 OURS POLAIRE**

Floor standing 3D  
H 2 x W 1,30 x D 1 m  
121 Kg - 324 W



**201375 BOUQUETIN 3D**

Floor standing 3D  
H 3,25 x W 2,45 x D 1,50 m  
119 Kg - 623 W



**201376 CHAMOIS 3D**

Floor standing 3D  
H 2,50 x W 1,90 x D 1,50 m  
67 Kg - 155 W



Bonhomme de neige 12 m | Londres 2006



**201374 BONHOMME DE NEIGE**

Floor standing 3D  
H 9 x Ø 3,80 m  
1150 Kg - 1140 W





200613 BALADE SOUS LES ÉTOILES

H 4 x W 3,40 m  
32 Kg - 212 W



Balade sous les étoiles | Clermont-Ferrand 2006





**200991 PORTE «PATINOIRE»**

H 7 x W 7 m  
90 Kg - 1210 W



**200992 PORTE «CHRISTMAS»**

3D  
H 6,30 x W 7,15 m  
111 Kg - 1300 W



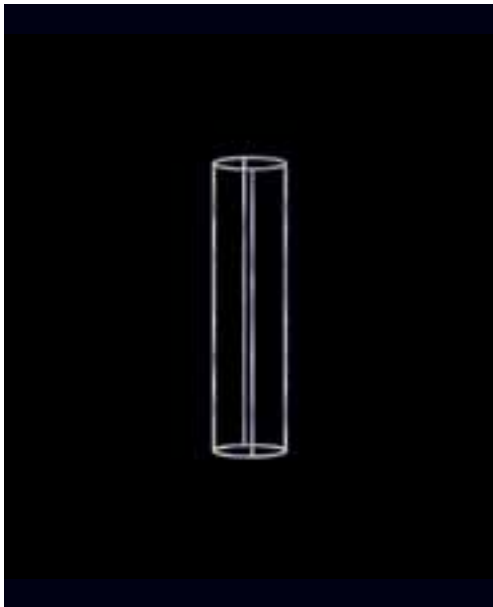

**200645 COLONNE**

3D  
H 1,25 x Ø 0,30 m  
6 Kg

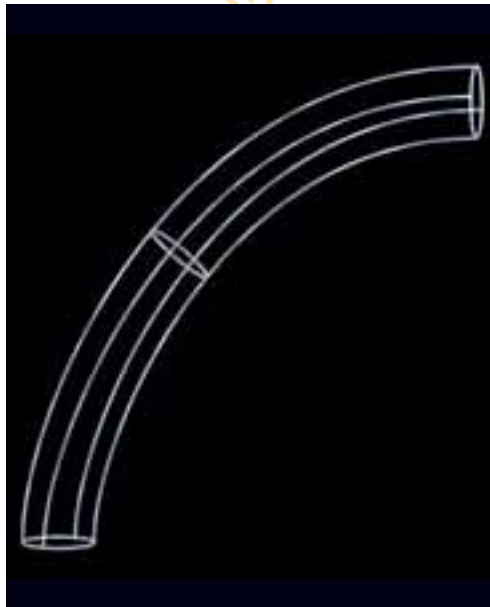

**200646 DEMI ARCHE**

3D  
H 2 x W 1,90 x Ø 0,30 m  
10 Kg

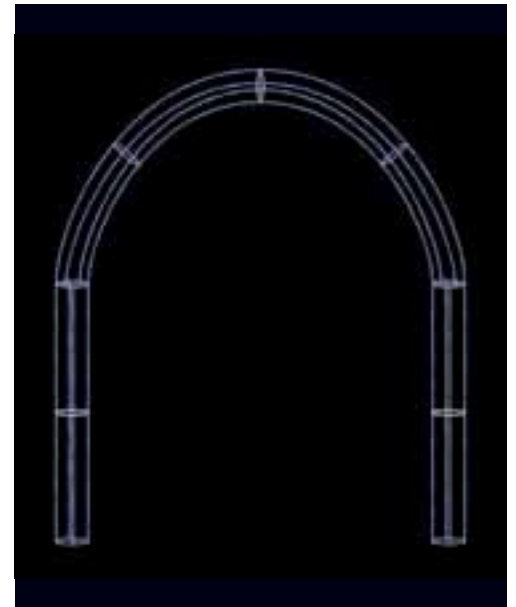

**EXAMPLE OF A MODULAR DOOR**

Presentation composed of 4 structures ref.200645 and 2 structures ref.200646  
H 4,50 x W 3,80 x Ø 0,30 m  
44 Kg



**DOORS TO COVER**

- Structures to assemble and cover with PVC Garlands, Maxileb or Maxi Brilliance LED®, garlands, ribbons, bows or rope light ...
- Elements to make decorations up to 8 m height.
- Production on request.
- Fastening system available according to your needs.

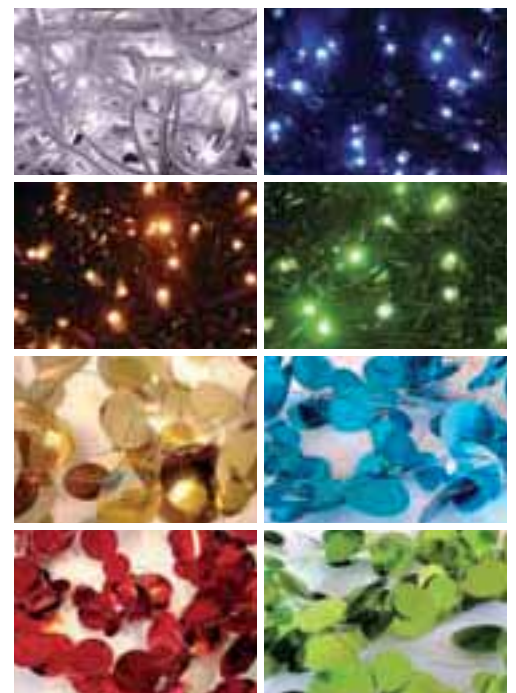

Bora | Angers 2009



Décors spécifiques | Nantes 2009



# Installations

*All our lamp columns decorations are supplied with post plates, all our street crossing & suspensions decorations are supplied with eye hooks.*

---



## Synchro system

### Communication technology through carrier currents

The Carrier Current controllers with a remote control enable you to produce new dynamic luminous animations by transmitting information on the local network without any modification of power supply cables of your installation.

Every light decoration is associated with a slave listed by its number. Depending on the programme selected, the master controller transmits the switching on/switching off programme to be run. The master controller causes the animation to start in synchronisation with all the controllers, thus creating a sequenced animation of all the luminous decorations.

### Simplicity & Flexibility

Information transmitted by the local electricity network\*  
 Insensitivity to surrounding structures (reinforced concrete, metallic structures)  
 Computer programmable with the AnimCreator® software (with more than 8 pre-recorded animations and one set programme)  
 Significant operative reach : 400 m between each decoration  
 Up to 31 decorations for a single master  
 Can be connected on three-phase + neutral, or single-phase

### Registered patent

Leblanc® Illuminations brings the heart of numerous towns to life with its carrier current synchronised animations, a patented process that is therefore exclusive to Leblanc® Illuminations.

#### 010007 MASTER CONTROLLER

Selection of the animations

#### 010008 SLAVE CONTROLLER

Installed on each motif or garland (max. 31)

#### 010005 ANIMCREATOR®

Programming software for PC

You install your decoration with a controller using carrier currents, just like any other decoration, and the synchronised decoration starts by itself !

Loches 2009



To see many animation possibilities go to :

[www.leblanc-illuminations.com](http://www.leblanc-illuminations.com)



Angers 2009



## Interactivity

### Interactive sight !

Visitors can be the director of the show. They will start the show, choose the timing and choose the programme.

Fully original, conceptual and surprising : adults and children alike will be amazed.

Easy to set up, these units will provide new outlets for creativity and will enable rediscovery of the city or its monuments.

The animation consists of :

- light sources to be animated
- slave controllers which receive animation instructions via carrier currents
- a master controller fitted with a touch sensor which loads the prerecorded animation programmes to the slave controllers

Easy to install, no cable required between the touch screen terminals and the animated illuminations.\*



Colour changing  
interactive column light

### 032155 INTERACTIVE CONTROL UNIT

Interactive control column with instructional touch sensor screen and animated controller.

### The principle is easy

Just touch the screen of an interactive kiosk : a synchronized lighting program will start.

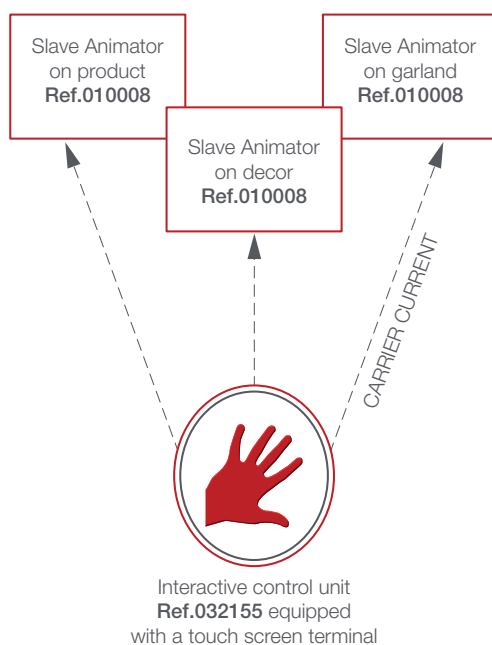

\* Groupe LCX® makes some reservations as for the good working of the system according to the various electric networks worldwide.

Arcachon 2009



## standards for temporary illumination installations

### NF C 17-200, C 17-202, NFC 15100

Our decorations comply with class 2 lighting insulation requirements. They therefore feature optimum protection in accordance with standards, providing maximum safety for the public and for installation professionals.

### Installations not accessible to the public

**Conditions :** Electrical equipment located at a height more than 3.00 m from the ground or projecting more than 1.00 m horizontally from a balcony, terrace or any area open to the public are considered to be inaccessible.

**Protection :** Maintained inaccessibility ensures protection against direct contact. Circuits must be protected from indirect contacts by a core balance transformer with average sensitivity. The connection must be made using fixed connections.

Non-fixed connections and electric sockets, even inaccessible ones, are protected by high sensitivity core balance transformers (30 mA).

If part of the temporary installation does not comply with the inaccessibility rules, the instructions in 5.1 must be applied at least to the part concerned.

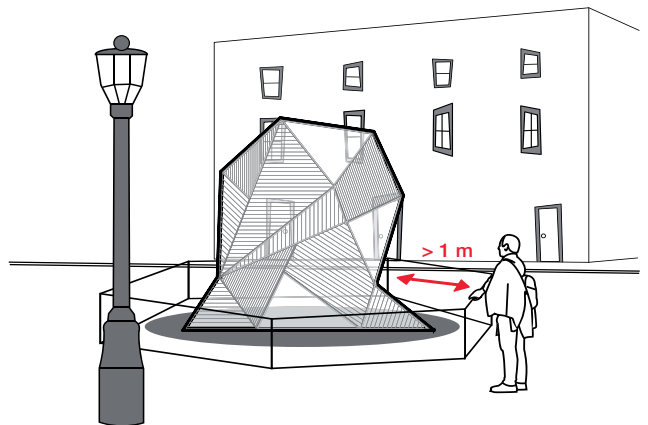
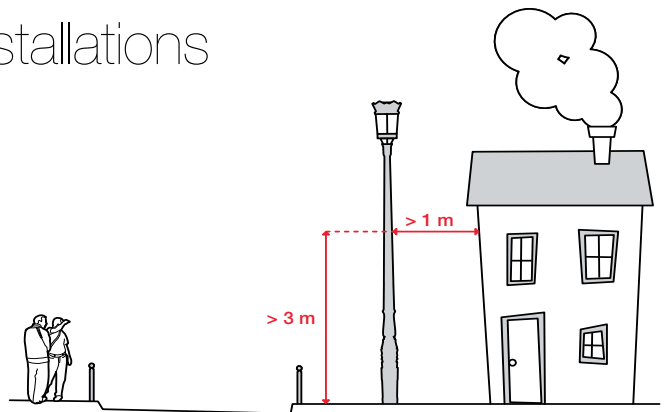

## Suspended decorations on brackets

### Assemble your fastening in 3 stages :

Choose a bracket according to the decoration width, plan the hanging kit, plan on the metal band and the clips (p.128).

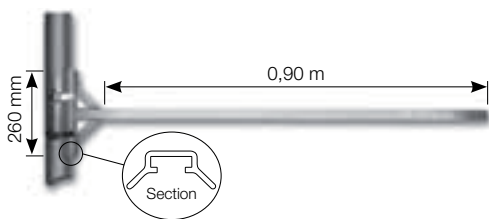

**792001** ALUMINIUM BRACKET 1 m  
**792101** ALUMINIUM BRACKET 1,20 m  
**792201** ALUMINIUM BRACKET 2 m  
Supplied by unit - Maximum load : 10 kg



### **792002** HANGING KIT

4 alpine karabiners 60 mm, 2 M6 eye hooks,  
2 x 1 m chain



### **032233\*** 3D HANGING KIT

1 alpine karabiner 60 mm, 1 M6 eye hook,  
2 nuts, 2 washers

## Fastening for across street decorations

### 113010 WALL/WALL KIT 6 mm

2 M12 capstan screws, 2 tensioners, 2 alpine karabiners 100 mm, 2 shackles, 6 cable grips, 2 wall plates



### 113020 WALL/LAMP COLUMN KIT 6 mm

1 M12 capstan screw, 2 tensioners, 2 alpine karabiners 100 mm, 2 shackles, 6 cable grips, 1 post plate + ring, 1 wall plate

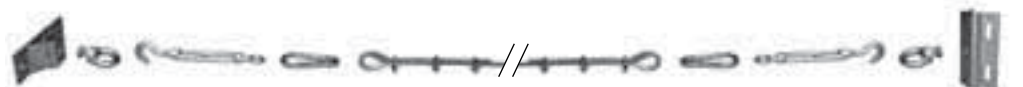

### 113030 LAMP COLUMN/LAMP COLUMN KIT 6 mm

2 tensioners, 2 alpine karabiners 100 mm, 2 shackles, 6 cable grips, 2 post plates + rings

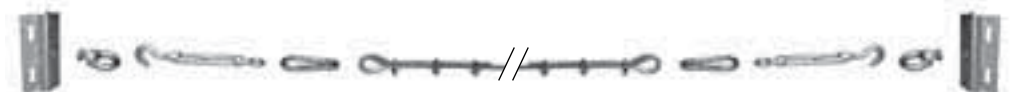

## Self-locking griple system

The Gripple replaces cable grips, thimbles and tensioners with its self-locking system. Ready to install, it provides total safety under dynamic load conditions.



### Safe & ingenious operation !



### 031953 SELF-LOCKING GRIPPLE SYSTEM

Two 6-mm self-locking Gripples, 1 setting key. Use on 6-mm diameter non-sheathed cable. Safety screw.

### Quick, effortless tensioning !



### 031954 GRIPPLE TENSIONING TOOL

The Gripple system is easy to tension using the exclusive Gripple tensioning tool.

# Fastening accessories for across street decorations

## Directions for use :

- 1 Open the Clip by squeezing both lugs on each side together.
- 2 Position the rapid fix under the catenary wire.
- 3 Close the Clip by releasing the lugs.

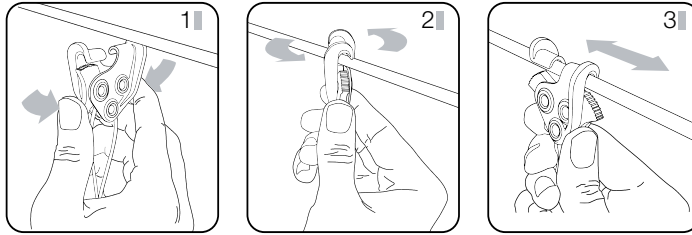

### GRUPE LCX® EXCLUSIVE



#### 032197 RAPID FIX CLIP

1 self-locking system + 1 Gripper + 1 tip fillet M10 + 2 nuts/washers Ø10 mm, + 1x 2 mm Ø x 1,15 m galvanised cable + 1 flag Key (Gripper)  
For use with 6 mm galvanised cable (sleeved or unsleeved)  
Maximum load 45 kg



#### 032198 SUSPENSION CLIP

1 self-locking system + 1 ring Ø 65 mm in galvanised cable (Ø 2 mm)  
For use with 6 mm galvanised cable (sleeved or unsleeved)  
Maximum load 45 kg



#### 031855 WALL PLATE

Supplied by unit



#### 031990 FASTENING KIT

1 nut, 1 washer, 1 M12 capstan screw,  
1 alpine karabiner 100 mm - 930 kg maxi.

#### 032220\* FASTENING KIT

2 nuts, 2 washers, 1 M10 capstan screw,  
1 alpine karabiner 100 mm



#### 100504 TENSIONER

Supplied by unit



#### 101640 CHAIN WITH SOLDERED LINKS

Length 1 m



#### 101300 STEEL CABLE 6 MM WITHOUT SLEEVE

Length 100 m  
Maximum load 2 730 kg

#### 060726 STEEL CABLE 4 MM WITH SLEEVE AT 6 MM

Length 100 m  
Maximum load 1 260 kg



#### 101500 FIMBLES 6 mm

Supplied by 10 pcs



#### 122900 SHACKLES

Supplied by 10 pcs



#### 031894 ALPINE KARABINERS

60 mm

Supplied by 10 pcs, Ø 6 mm

#### 031895 ALPINE KARABINERS

100 mm

Supplied by 10 pcs, Ø 10 mm



#### 100503 MANILLES

Supplied by 10 pcs

# Fastenings

for circular decorations on lamp columns

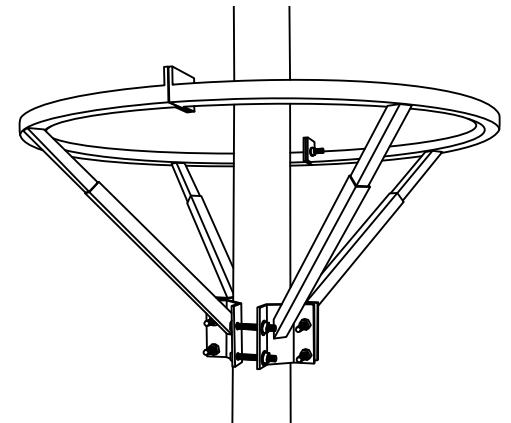

**031937 SIMPLE CROWN Ø 600 mm**  
**031938 SIMPLE CROWN Ø 800 mm**  
 For pole Ø between 60 and 200 mm maximum

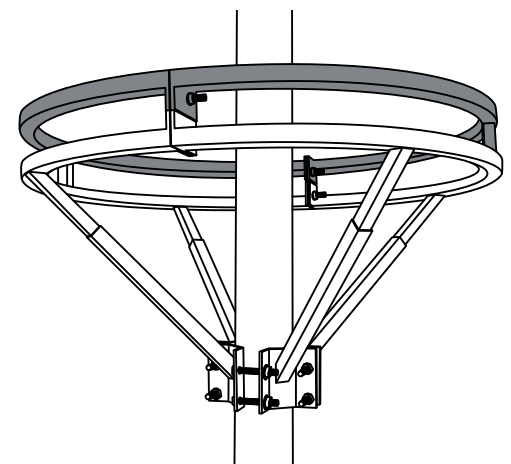

**031939 CROWN EXTENSION  
 Ø 600 mm**  
**031940 CROWN EXTENSION  
 Ø 800 mm**  
 For pole Ø between 60 and 200 mm maximum.  
 The crown extension enables installation  
 of more curtain lights and animated cones.

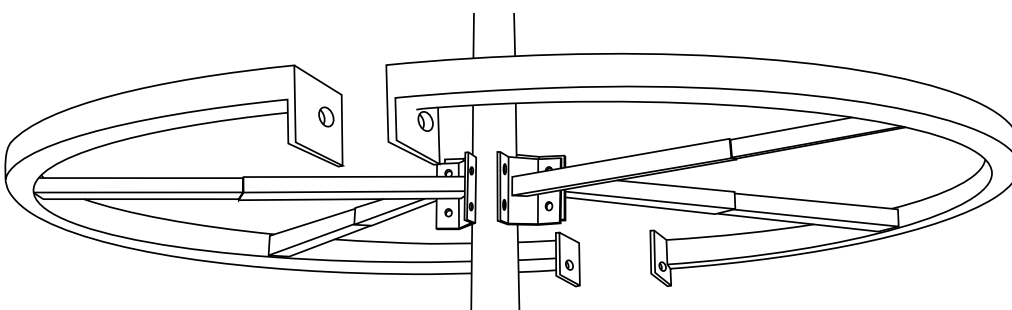

**031941 BIG SIMPLE CROWN Ø 2 M**  
**031942 BIG SIMPLE CROWN Ø 4 M**  
 For pole Ø between 60 and 350 mm maximum

## Fixing for 4 sides lamp columns

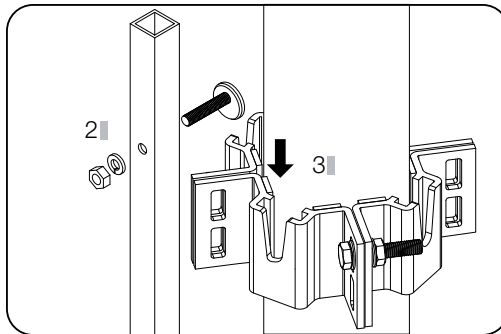
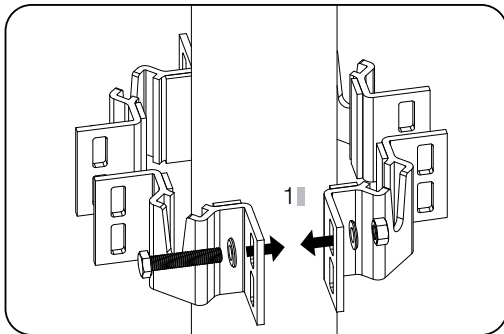

### Directions for use - with screws :

- 1|| Hang on 4 plates around the pole with the nuts and bolts loosely.
- 2|| Set the fixing pole with screw, washer and nut on the set.
- 3|| Slide the assembly into the plate and tighten. Repeat step 2 for every decor.

Plate to fix on the pole with the strap

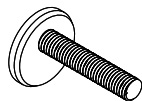
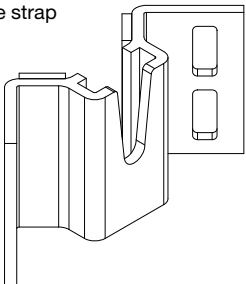

Fastening part to fix on the decoration

### 032242\* 4 SIDES RAPIDE FIX

4 plates with protection, 4 fastening parts, 4 washers, 8 nuts Ø 10 mm, 4 screws HM10x60, 8 washers Ø 10, 4 screws HM10x120

Suitable for cylindrical, hexagonal or octagonal lamp columns of a diameter from 100 mm to 200 mm (other types of lamp columns, please contact us)

**New 4 sides fastening :  
in less than fifteen minutes, up to 4 decorations are installed !**



One ref.032242 is enough for an installation in 4 parts.

Cergy 2008



## Fixing for standard lamp columns

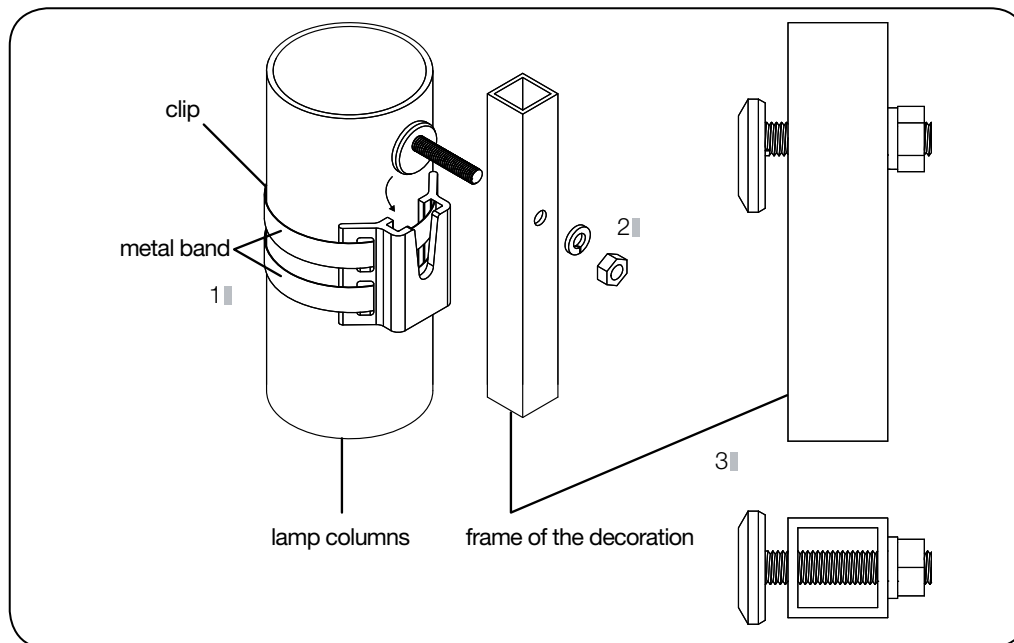

### Directions for use :

- 1 Fix the plate on the pole with the metal band and the clips.
- 2 Fix the fastening part, with the screw, the collar and the nut on the motif. Slip the set into the plate and tighten.
- 3 The fastening part, the collar and the screw remain on the motif, once it is taken down. The plate remain fixed to the pole thanks to the metal band.

### Avantages :

- Quick installation
- Low space required for this new fastening.
- No more stocking problem for the fastening

Plate to fix on the pole with the metal band

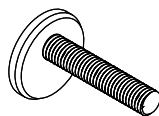
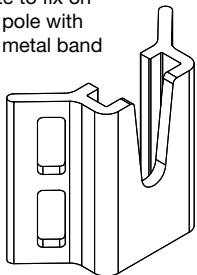

Fastening part to fix on the decoration



### 032180 STRAP

L 1 m x W 25 mm

Thickness : 2 mm

Stretcher included - 1 600 kg maximum

### 032094 RAPIDE FIX

1 plate, 1 fastening part, 1 washer, 3 nuts Ø 10 mm, 2 screws HM10x60, 4 washers Ø 10 mm



### 060637 POST PLATE PROTECTION

Rubber foam band self-adhesive on one side  
L 10 m x W 18 mm



### 031854 EOLEB FIXING

1 Eoleb spring, 1 screw 10 x 50 mm, 1 screw 10 x 30 mm

Caution : 4 kg maximum per Eoleb (example : for a 11 kg decoration you need 3 Eoleb fixings).



### 031852 RING

1 ring, 1 screw 12 x 30 mm

# Fixing for standard lamp columns



**122250 BAND PROTECTION**  
Rubber band - Roll of 10 m



**031955 TOOL CASE FOR CRIMPING PIECES**

1 strap device with screws, 1 shear, 1 bending pliers, 1 hammer, 1 set of 100 crimping pieces for 18 mm band



**722101 SUPPORT FOR CONCRETE POST**

1 element, L-shaped, suitable for any concrete post  
H 100 mm x W 300 mm



**122300 STAINLESS METAL BAND**  
L 30 m x W 18 mm  
Thickness : 0,50 mm

**122500 GALVANIZED METAL BAND**  
L 25 m x W 18 mm  
Thickness : 0,40 mm



**031951 SET OF CRIMPING PIECES**  
Supplied by 100 pcs

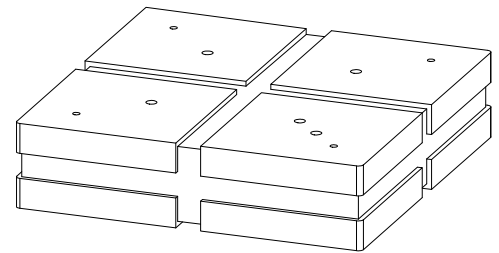

**032212\* CONCRETE PAD**  
Superposable concrete pad  
H 170 x W 700 mm - 200 Kg

**032241\* CONCRETE PAD FASTENING KIT**  
4 threaded rods, 8 nuts, 8 washers  
Enables to set a pole on one or more blocks  
ref.032212.



**001949\* STORAGE RACK**  
W 1,78 x D 0,96 m

**001948\* PILLARS**  
H 1,68 m - Supplied by 4 pcs

**001982\* STORAGE AND TRANSIT TROLLEY**  
Please contact us

## Electric connections

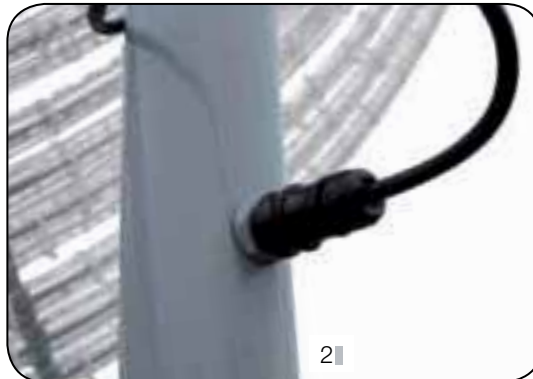
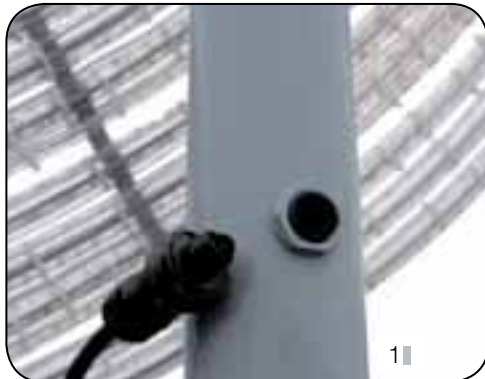

### Directions for use :

- 1 || Drill the pole  $\varnothing$  25 mm. Install and connect the angled connector cable to your post.
- 2 || Connect the male connecting cable to your decoration, then plug it into the female end of your angled connector cable.

**Your electrical connection is complete !  
Your installation is connected safely.**

During the rest of the year, protect your angled connector cable with a stopper for a female connector.



#### 059556 ANGLED CONNECTOR CABLE

Cable with angled female connector for lamp column with connecting cable with bared end W 6 m - IP 68 - 3G1,5 mm<sup>2</sup> H07RNF black cable 20 A maxi.



#### 059557 CAP FOR FEMALE CONNECTOR

Cap for female connector, black with safety lead



#### 059558 MALE CONNECTING CABLE WITH BARED END - 2 m

#### 059559 MALE CONNECTING CABLE WITH BARED END - 3 m

Male cable with connecting cable with bared end IP 68 - 2G1,5 mm<sup>2</sup> H07RNF black cable 20 A maxi.

## Plug & Light convenient, easy, quick

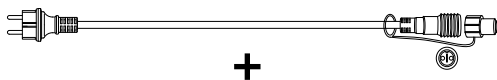

#### 031978 POWER SUPPLY CORD + ADAPTER - W 3 m

#### 032185 POWER SUPPLY CORD + ADAPTER - W 5 m

#### 031979 POWER SUPPLY CORD + ADAPTER - W 7 m

Supplied with adapter for connectors  $\varnothing$  2,75 mm to  $\varnothing$  2,35 mm (ref. **059238**).

3 680 W maxi for power supply cord only, 1840 W maxi when using adapter.

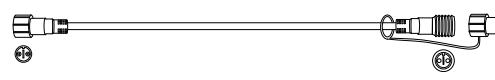

#### 059072 2 WIRED EXTENSION CABLE W 2 m

#### 031903 2 WIRED EXTENSION CABLE W 3 m

$\varnothing$  2,35 mm  
1840 W maxi.



#### 060710 UNSHEATHED 2 WIRED MAXILEB CORD - W 1,70 m

#### 058968 UNSHEATHED 2 WIRED MAXILEB CORD - W 3 m

Enables connection of an animation controller to a static Maxileb product  $\varnothing$  2,35 mm 1 840 W maxi.

All the Leblanc® Illuminations decorations are equipped with a power box and a Plug & Light male connector 2 pins  $\varnothing$  2,75.

## Controllers

- Waterproof box IP54, insulating thermoplastic
- 230 V - Connection by cable gland (not supplied)
- Can be joined together : 4 mm<sup>2</sup> rigid Monofil, 2,5 mm<sup>2</sup> flexible Multifil
- Large interior volume for connections
- Bipolar terminal board for each incoming or outgoing cable
- Flash frequency can be regulated by a potentiometer

**105000** FLASHER 1X5 A**205000** FLASHER 2X5 A**031858** CABLE GLAND**059708** 2 WAYS CONTROLLER

2 ways controller with convertor for power box :

- Change-over between the 2 ways
- Flash between the 2 ways
- Twinkling alternated between the 2 ways, then synchronized
- Flash alternated between the 2 ways, then synchronized

**010001** ANIMATOR

4 x 5 A - 10 programs (P0 to P9)

**058298** ANIMATOR

4 x 16 A - 16 programs (P0 to PF)

Animations of 4-way animation controllers :

- P0 : scrolling
- P1 : P0 + Flash
- P2 : piling-up
- P3 : P2 + Flash
- P4 : negative scrolling
- P5 : P4 + Flash
- P6 : forward / back
- P7 : piling-up/unpiling
- P8 : negative go & back
- P9 : flashing 1/2 & 3/4
- PA : P0+P2+P4+P1+P3
- PB : P5+P6+P7+P8+P9
- PC : flashing 1/2 & 3/4
- PD : PC + flash
- PE : 4 forward / back + flash
- PF : alternative scrolling

## Protection boxes

**010012** AUTO RE-SETTING CIRCUIT BREAKER PROTECTION BOX

1 bipolar plug + earth, a 30 mA circuit breaker with automatic re-setting, single, a 10 A fuse holder, 1 earth terminal

It connects automatically when power is applied to the installation. It disconnects automatically in the event of earth fault current.

Disconnection speed in accordance with standards relating to RCDs.

Following disconnection, it performs 3 pre-programmed reset attempts (as standard : 10 secs / 2 mins / 1 hr. Other configurations on request). If the defect persists after the third attempt : total disconnection until the following day. Power restoration will reinitialise the earth leakage circuit breaker

**010011** DIFFERENTIAL PROTECTION CASE WITH AUTOMATIC RESET

1 bipolar plug + earth, 1 manual 30 mA circuit breaker a 10 A fuse holder, 1 earth terminal

**060271** WATERPROOF CONNECTION CASE

Provides safety and weathertightness for outdoor connectors, 16-A male/female straight connector + connector securing device

**010014\*** ENERGY SAVING

Enables stopping and restarting the illuminations in predefined periods : 7h stop after power, reset 6h (fixed) after stopping.

Automatic disconnection, automatic reset (guide UTE NF C17-210).

10 A - 2300 W - 300 mA

This product is designed to be mounted directly on plexo box sets, by yourself or in our factory.

Important: you must install a **non auto reset** 30 mA circuit breaker at the upstream end of your installation.

Pommes givrées | Angers 2009



Sphères LED 3D | Puteaux 2008



Sapin et Bonhomme 3D | Puteaux 2008



Trésors & plafond LED | Le Mans 2009



Salon du développement durable | Valenciennes 2010



# Services

*For 50 years, Leblanc Illuminations® has symbolised the best in festive lighting.*

---



# Single point of contact for all your decorative lighting projects

**Groupe LCX®** - Expert in Lighting has the specialised knowledge in every field of decorative lighting at your disposal.

Groupe LCX® is a leader in the design and manufacture of festive lighting for local authorities, leisure venues, shopping centres and private individuals.

Driven by the same commitment to quality and professionalism, its three strong brands, Leblanc® Illuminations, Chromex® and Starway®, provide you with the assurance that your decorative lighting project will match the original concept.

Show room itinérant | Bordeaux 2010



Arcachon 2009



Institut du Monde Arabe 2008



Hérouville St Clair 2008



Annecey 2009



Star Ac'



■ **Leblanc® Illuminations**, french designer and manufacturer of luminous decorations.

Leblanc® Illuminations combines the constant quest for new products and services with innovative design in the creation and manufacture of decorative lighting. Leblanc® Illuminations rethinks urban space and, through the magic of light and beauty of forms, gives it a festive air.

Every year, Leblanc® Illuminations renews more than 30% of its range of decorations. In its *Prestige Book of Inspiration*, Leblanc® Illuminations demonstrates its expertise and its leadership in terms of design, choice of colours and harmony of materials. The Leblanc® Illuminations *Street decorations* catalogue offers an extensive range of decorations and exclusive new products.



■ **Chromex®** combines simplicity and technology in the creation of decorative lighting.

Chromex® offers festive illumination equipment to town and city councils and lighting professionals, but also to a mass market through many of the major names in DIY and food retailing.

More than 900 references of garlands, curtain lights, bulbs, LED architectural lighting products, decorations and other luminous products essential to a successful decoration.

**CHROMEX®**

■ **Starway®**, specialist in events' lighting.

CSI is one of the biggest names in event lighting.

Theatres (salle Pleyel, le Sporting, etc.), television studios (Star Ac', Nouvelle Star, Taratata, Qui veut gagner des millions, etc.), concerts (Mylène Farmer, Johnny Halliday, Michel Polnareff, etc.), trade fairs (Mondial de l'Automobile, Club Med Vittel, etc.).

The best professionals use CSI and its Starway brand.

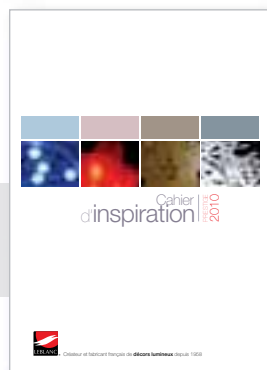

Book of inspiration

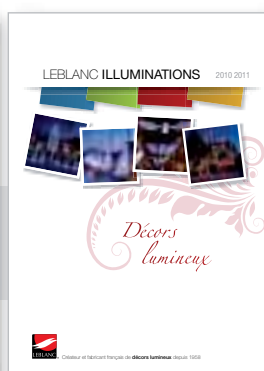

Street decorations

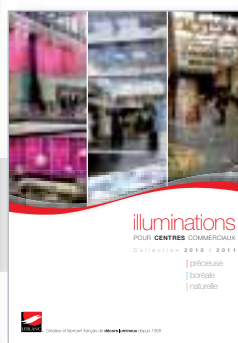

Shopping centres Collection



Chromex® Collection

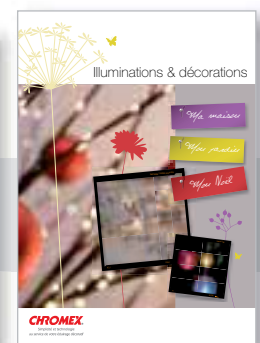

Chromex individuals

Leblanc Illuminations® Catalogues 2010 2011

Chromex® Catalogues 2010 2011

# Illuminations around the world

Espagne 2008



Naples 2009



## In France

Leblanc® Illuminations concretises the lighting projects of more than 7500 cities each year.

In 2010, Biarritz is adorned with gold and silver, Sanary sur Mer turns its roundabouts into treasure islands, Nice plunged into a snowy landscape with silvery, Caen banks on the water theme and Brest invites to lightness through its round shapes and bubbles ...

## In Europe and Around the world

« Made in France »

The 'French Touch' of Leblanc® Illuminations appeals to many foreign markets: Canada, Austria, Great Britain, Germany, Switzerland, Andorra, Monaco to name just a few. Leblanc® Illuminations is also present in the imperial cities of Morocco, in Mauritania, in the United Arabs Emirates, Ivory Coast, the Caribbean and the Indian Ocean.

Canada 2009





# illuminations, a turnkey project

## Project design study

"Let's talk and shape your lighting project together"

Your idea is unique ...

- colour & form
- setting & theme
- indoor/outdoor
- interactivity

... our team is listening to you ...

Located close to you, our sales team conceives the unique, personalised project, tailored to your requirements.

... and conducts a feasibility study on site

- site photos
- site measurements
- technical and project-specific constraints

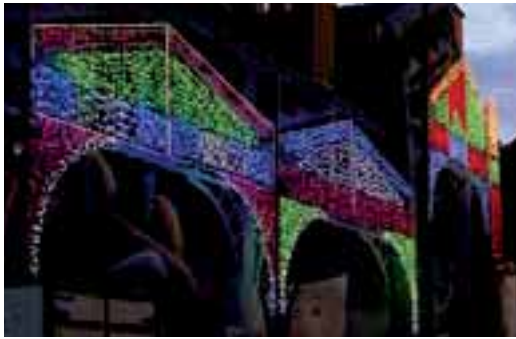

## Design & staging

«Making the lighting project a true work of art»

- Confirmation of technical feasibility
- Project costing
- Superimposition of decorations on photos
- Adaptation of decorations and staging throughout the design phase



" We create your custom decorations and give you a substantive vision of your project. "



Ateliers de soudure



### Made in France

“Our know-how dedicated to your project”

Your project takes shape in the largest manufacturing facility in France: 20,000 m<sup>2</sup>.

Visit on request to our 600 m<sup>2</sup> showroom, our worlds of light and our products.

Montpellier 2009



The Leblanc® Guarantee: quality and safety

- Low energy consumption
- Products certified by accredited laboratories
- Integrated inspection laboratory

Clermont Ferrand 2009



\*sous certaines conditions

## Sustainable illuminations: a few examples of initiatives\*



### Economy

#### Energy Collective Support Programme

In collaboration with ADEME (French Environment and Energy Management Agency), the Pays de la Loire Region and Le Mans Chamber of Commerce & Industry, Leblanc® Illuminations has established an Energy Collective Support Programme.

Following an audit by an independent expert, Leblanc® Illuminations is reducing its energy consumption while moving towards the use of renewable energy.

In parallel with efforts to raise awareness within the company, Leblanc® Illuminations is implementing landmark initiatives promoting natural and renewable energy sources.

At stake: the generation of 35.5 tonnes of CO<sub>2</sub> avoided each year

7 sets Sapin LED ondulé (réf.201175) consum less energy than a hair dryer



#### Energy savings offered by the products

Committed to protection of the environment, Leblanc® Illuminations is constantly innovating and offering a more energy-efficient range of products.

All of Leblanc® Illuminations decorative lighting incorporates LEDs, which are economical and contain no hazardous substances (in accordance with the RoHS Directive). Having very low power consumption, these LED products enable energy savings of 70% compared to conventional incandescent bulbs, with much higher overall luminous output and service life.

### Environment

#### Recycling

95% | Leblanc® Illuminations decorations are 95% recyclable.

Sustainable product management also requires monitoring throughout their life cycle. Furthermore, under a leasing agreement, Leblanc® Illuminations is committed to taking back the decorative lighting at the end of its life and assuming responsibility for its recycling.

Aware of the challenge posed by recycling and waste reclamation, Leblanc® Illuminations has implemented systematic in-house sorting of all waste generated by its activity.

Under the WEEE directive, Leblanc Illuminations® is a member of accredited bodies such as ERP (European Recycling Platform) or Recylum, of which Leblanc® Illuminations is a partner and founding member.

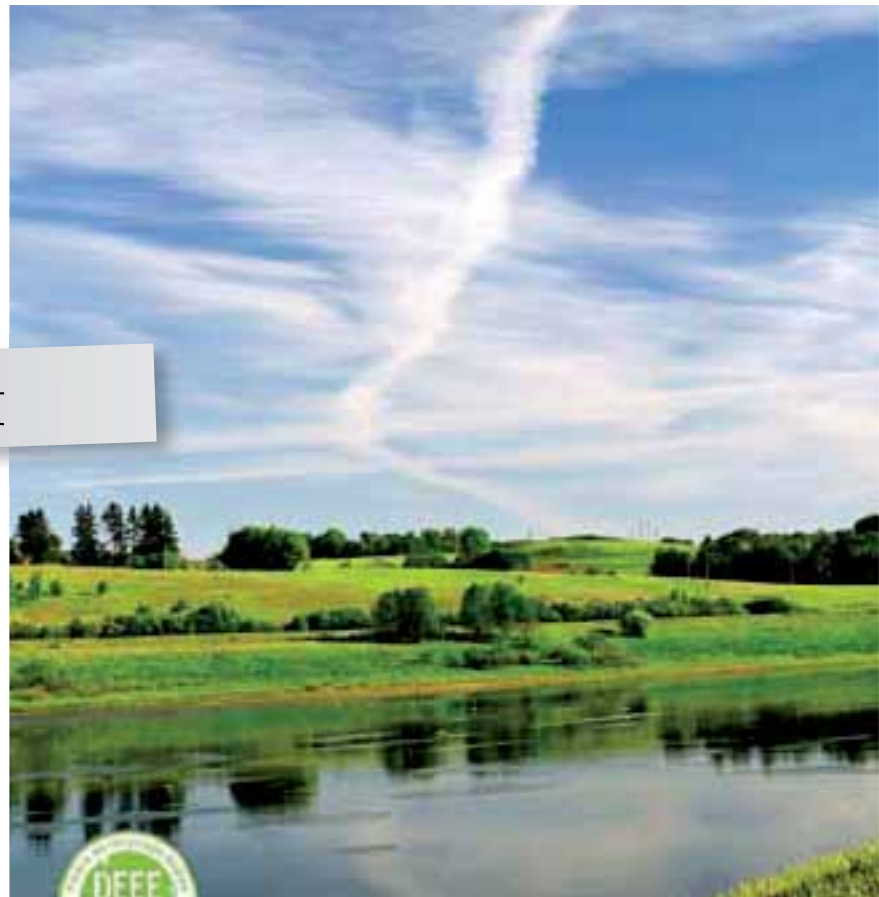



## Carbon offsetting

Leblanc® Illuminations is an active participant in a CO<sub>2</sub> emissions offsetting programme.

In partnership with EcoAct, Leblanc® Illuminations has launched a reforestation programme in the Sainte Victoire Mediterranean forest near Aix-en-Provence and in the Mata Atlântica tropical forest in Brazil (designated a «World Biosphere Reserve» by UNESCO).

As proof of this action, Leblanc® Illuminations offers customers who so require a **carbon offset certificate** certifying the number of trees planted in connection with their lighting project.

## 4 500 trees planted

This initiative has already seen Leblanc Illuminations® plant :

4,000 trees in the Mata Atlantica forest  
500 trees in the Sainte Victoire massif

## Welfare initiatives



### Partnership: Les Blouses Roses



The year-end holidays are a time for sharing and generosity. Unfortunately, many children cannot enjoy the magical world of illuminations at Christmas time, particularly those who are in hospital.

Leblanc® Illuminations wants to change this and bring smiles to the faces of children who are going through a difficult time. **Beginning at Christmas 2010, in conjunction with Les Blouses Roses association, Leblanc® Illuminations is decorating their care facilities.**

Founded in 1944, the association's mission is to entertain the sick, elderly or handicapped, through fun activities.

Today, 632,000 people throughout France are beneficiaries of Les Blouses Roses, thanks to the 3,600 volunteers.

For more information: [www.lesblousesroses.asso.fr](http://www.lesblousesroses.asso.fr)



Thanks to this programme, illuminations are still associated with celebrations, but are also synonymous with social responsibility and respect for the environment.

reference	page	reference	page	reference	page	reference	page	reference	page
<b>A</b>		Concrete pad	128	Frémissement	37	Lyre céleste	9	<b>R</b>	
Aba	83	Concrete pad fastening kit	128	Frisson	37			Rapide Fix	127
Adèle	51	Connection case	130	Fuji	58	<b>M</b>		Rapide Fix - 4 sides	126
Akai rouge	67	Controller	130			Majesté	44	Rapide Fix clip	124
À la folie	55	Copernic	10	<b>G</b>		Male connecting cable	129	Ring	127
Aliot	107	Courant d'air led	94	Galilée	10	Manilles	124	Ruban scintillant	89
Alpine Karabiners	124	Cours d'eau	13	Galopade	98	Marquise flamboyante	64	<b>S</b>	
Aluminium bracket	122	Crépuscule	100	Giboulée	108	Marquise violette	62	Sakura	41
Alya bleu	69	Crimping pieces	128	Gibraltar	53	Masao bleu	67	Sapin enchanté	107
Alya or	79	Crown extension	125	Ginkgo	67	Master controller	120	Sapin givré	42
Amy	82	Cyclone	52	Gloria argent	76	Mauna	85	Sapin gracieux	45
Andalousie bleu	23	Cylindre vidéo	16	Gloria cuivre	76	Méditerranée	52	Sapin ondulé	79
Andalousie or	91	<b>D</b>		Gloria flamboyante	65	Meiji	40	Sapin paillé	72
Andy	67	Delphes	89	Gloria violette	63	Meilleurs Vœux	98	Sapin vidéo	16
Ange 3D	112	Demi arche	117	Goutte LED	28	Melchior	111	Sarrazin	52
Angled connector cable	129	Demi losange	31	Grand auro	99	Metal band	128	Shackles	124
AnimCreator®	120	Diamantine	108	Grand cristal de lumière	103	Mobile d'argent	105	Sierra	105
Arabesque	27	Diane rose	63	Grande boule magique	101	Molière	14	Simple crown	125
Arbre de lumière 3D	43	Differential protection case	130	Grand florilège bleu	7	Mont d'or	93	Sirène	18
Arbre perlé 3D	43	Disque scintillant	10	Grand pin cascade	20	<b>N</b>		Sirocco	104
Arbre scintillant	43	Doria argent	77	Grand volga	36	Newton	11	Slave controller	120
Arcane argent	67	Doria cuivre	77	Gripple system	123	Nuit des étoiles	102	Sonate	70
Arcane rose	63	Double cône d'argent	20	Gripple tensioning tool	123	Nymphé	68	Source miraculeuse	6
Arche glacée	98	Drapé céleste	9	<b>H</b>		<b>O</b>		Sphère scintillante	101
Artimon	14	Dyna	34	Helima	107	Onde de glace	108	Sphère LED prestige	66
Arwen	8	<b>E</b>		Hélio	106	Onde givrée	15	Sphère paillé	96
Au fil de l'eau	19	Échappée	32	Hélios	10	Ondine	12	Steel cables	124
Auro	99	Échappée belle	33	Himalaya	53	Onduleb stalactite	28	Strap	127
Aurore rose	63	Écharpe	31	Horus	49	Oracle	89	Sucre d'orge	65
<b>B</b>		Écharpe de lumière	30	<b>I</b>		Orchidée sauvage	57	Support for concrete post	128
Babel	55	Écharpe d'or	31	Interactive control unit	121	Ours	113	Suspension clip	124
Babylone	54	Écho	26	Iris rose	63	Ours polaire	113	<b>T</b>	
Balade sous les étoiles	115	Echosphère	100	Isida	95	Ovation	71	Taïga	69
Band protection	128	Écrin	29	<b>J</b>		<b>P</b>		Tensionner	124
Belle nuit des étoiles	103	Élégance	27	Jasmine	88	Pandore	84	Théâtre	34
Big simple crown	125	Elena	94	Jeannelle	46	Pastel	97	Tombée de lumière	13
Bijou	100	Elissa	25	Jeni argent	75	Pépita	103	Tombée d'étoiles	105
Biloba	66	Élixir bleu	73	Jeu d'anneaux	109	Pépite	102	Tool case for crimping pieces	128
Bleu d'étoiles	105	Élixir rose	62	Jeu de cristal	109	Perce-neige	82	Toque argentée	31
Bleu filant	33	Energy saving	130	Jeu de flocons	109	Père Noël	112	Tourbillon	27
Bol d'air	95	Enki	24	Jeu solaire	109	Persia	50	Traîneau enchanté	111
Bonhomme de neige 112,	114	Enlil	25	Joyau	100	Petit cristal de lumière	103	Trésor	80
Bonne année scintillante	98	Entracte	35	Joyeuses fêtes dyn.	94	Petit dyna	35	Trésor en suspension	81
Bora	14	Eoleb fixing	127	Joyeuses fêtes pétillant	96	Petite arabesque	27	Two wired extension cable	129
Boréal	26	Esquisse	97	<b>K</b>		Petite colline d'or	93	Typhon	55
Boule magique blanche	101	Etna	85	Kakemono	76	Petite échappée belle	33	<b>U</b>	
Boule magique rouge	96	Étoffe	13	Hanging kit	122	Petite écharpe	31	Uburoi	67
Bouquetin 3D	113	Étoile 2D effet 3D	110	Hanging kit - 3D	122	Petite elena	95	Unsheathed maxileb cord	129
Braise	105	Étoile 3D blanche	105	Kansai	59	Petite jeannelle	46	<b>V</b>	
Breva	67	Étoile d'airain	110	Kelya bleu	68	Petit enki	24	Veillée de Noël	57
Brise	95	Étoiles pour traîneau	111	Kelya or	78	Petite nuit des étoiles	103	Vent céleste	9
<b>C</b>		Éventail	90	<b>L</b>		Petite pépita	103	Versailles	48
Cable gland	130	<b>F</b>		Lamp column/LP kit	123	Petite florilège bleu	7	Viviane	18
Cache-cœur	73	Fable	56	Lampion	29	Petit joyau	100	Voilage d'hiver	56
Cannelle	47	Fastening kit	124	Lanterne d'hiver	58	Petit trésor	81	Voile bleu	33
Cap for connector	129	Fimbles	124	Les dessous de ...	44	Petit ysis	91	Voile d'hiver	56
Chain	124	Flamenco bleu	23	Linéa	22	Pin cascade	20	Volga	36
Chamois 3D	113	Flamenco or	91	Liseur	91	Pin d'or	20	<b>W</b>	
Cime	20	Flanelle	47	Lueur	57	Pomme d'amour	65	Wall/Lamp column kit	123
Circus	88	Flashers	130	Lueur céleste	9	Pomme givrée	35	Wall plate	124
Claris	25	Flocons filants	92	Lustre à pampilles	74	Pompéi	84	Wall/Wall kit	123
Clip	128	Flocons rayonnants	92	Lustre lapony	69	Porte «christmas»	116	<b>Y</b>	
Collier de perles ambré	75	Flocons tourbillonnants	69	Lustre paillettes	72	Porte «patinoire»	116	Ysis	91
Collier de perles argent	75	Flora bleue	7	Lustre perce-neige	74	Post plate protection	127		
Colline d'or	93	Florine	6			Power supply cord	129		
Colonne	117	Fougère	55						
Comptine	56								

reference page	reference page	reference page	reference page	reference page	reference page	reference page							
001948*	128	060637	127	200879	55	201147	100	201299	67	201381	81	201507	102
001949*	128	060710	129	200880	52	201167	107	201303	67	201382	53	201508	103
001982*	128	060726	124	200881	55	201175	79	201304	67	201383	111	201509	103
010001	130	100503	124	200897	27	201180	94	201305	63	201423	30	201510	33
010005	120	100504	124	200910	43	201181	95	201306	67	201424	31	201511	101
010007	120	101300	124	200978	109	201182	95	201308	67	201425	31	201512	95
010008	120	101500	124	200980	109	201189	76	201311	58	201426	46	201519	103
010011	130	101640	124	200981	109	201196	105	201313	24	201427	46	201551*	18
010012	130	105000	130	200991	116	201198	65	201314	91	201428	92	201552*	18
010014*	130	113010	123	200992	116	201202	101	201315	66	201429	93	201553*	25
031852	127	113020	123	201001	31	201203	96	201316	66	201430	93	201554*	9
031854	127	113030	123	201011	74	201212	98	201317	13	201431	93	201555*	9
031855	124	122250	128	201031	62	201218	105	201319	25	201432	102	201556*	9
031858	130	122300	128	201032	64	201219	56	201321	99	201433	103	201557*	43
031894	124	122400	128	201035	75	201220	56	201322	99	201434	103	201558*	47
031895	124	122500	128	201037	77	201221	33	201323	98	201438	36	201559*	47
031903	129	122900	124	201038	76	201223	80	201325	107	201439	36	201560*	49
031937	125	200503	98	201039	63	201225	20	201326	106	201440	37	201561*	48
031938	125	200516	57	201040	65	201227	13	201328	109	201441	37	201562*	50
031939	125	200517	57	201043	76	201229	100	201330	69	201448	85	201563*	54
031940	125	200532	107	201045	62	201230	77	201332	29	201449	85	201564*	55
031941	125	200542	28	201050	27	201234	96	201333	14	201453	6	201565*	65
031942	125	200543	28	201056	55	201235	96	201334	68	201456	6	201566*	70
031951	128	200566	98	201057	82	201238	98	201336	20	201459	6	201567*	71
031953	123	200567	98	201058	110	201239	98	201337	20	201462	7	201568*	72
031954	123	200613	115	201062	12	201240	94	201338	20	201465	7	201569*	84
031955	128	200630	44	201063	22	201241	94	201339	13	201468	7	201570*	84
031978	129	200631	44	201064	22	201266	82	201340	104	201480	63	201571*	89
031979	129	200633	6	201068	74	201268	91	201341	105	201481	63	201572*	89
031990	124	200645	117	201069	29	201269	23	201342	90	201482	63	201573*	89
032094	127	200646	117	201071	82	201270	91	201343	96	201483	31	201574*	92
032155	121	200697	108	201072	83	201271	23	201344	69	201484	30	201575*	97
032180	127	200700	108	201073	83	201272	40	201348	111	201485	31	201576*	97
032185	129	200723	105	201075	72	201273	41	201349	111	201486	30	201577*	16
032197	124	200725	112	201077	45	201276	8	201350	108	201487	94	201578*	16
032198	124	200728	53	201078	45	201277	43	201351	105	201488	110	201579*	10
032212*	128	200773	28	201079	42	201278	24	201352	67	201489	33	201580*	10
032220*	124	200775	113	201082	73	201279	25	201355	107	201490	31	201581*	11
032233*	122	200779	113	201087	94	201280	91	201356	67	201491	31	201582*	31
032241*	128	200795	56	201089	98	201281	91	201358	14	201492	95	201583*	9
032242*	126	200801	56	201090	73	201282	79	201359	14	201493	103	201584*	10
058298	130	200804	105	201106	96	201283	69	201360	26	201497	34	201585*	10
058968	129	200812	112	201112	81	201284	78	201362	20	201498	35	201586*	101
059072	129	200837	112	201113	69	201285	68	201368	34	201499	51	205000	130
059556	129	200865	27	201122	35	201288	58	201369	35	201501	33	722101	128
059557	129	200866	75	201135	27	201292	88	201373	57	201502	33	792001	122
059558	129	200867	75	201137	100	201293	88	201374	114	201503	32	792002	122
059559	129	200870	19	201138	100	201294	66	201375	113	201504	32	792101	122
059708	130	200872	15	201139	100	201296	67	201376	113	201505	33	792201	122
060271	130	200878	52	201146	26	201298	59	201380	52	201506	103		

**Design & Execution :**

Marketing & Design • Groupe LCX® January 2011  
 SAS with 7 937 000 € capital - SIRET 482 323 649 000 20 - APE 4690Z  
 RCS 482 323 649 - FR 37 482 323 649  
 Claire Coquet • Atelier 320

**Photo credits :**

P. Brechet, P. Thourault, Les Blouses Roses, T. Bignolet, T. Vincent, M. Petit, Eleven Photo, Media Photo, G. Philippart, F. Devie, Archive Loto - Québec, L. Carpentier, Mairie de Pamplune, P. Gisselbrecht, F. Chappaz, Citelum, X. Nicostrate, I. Guégan, P. Domec, Gerard Photo, O. Blaise, C&D Photo, C. Victor, André Paul Jacques, GalaLights, M. Mullot, F. Cavazzana, J. Blanchard, F. Castel photographies, Anatolij Kivrnis © Fotolia, R. Wailliez, Groupe LCX®

Non contractual pictures & documents. All our decorations are protected by patents at INPI & OMPI. All specifications relative to the decorations are provided for information only and may be revised. Any reproduction, whole or partial, of the catalogue is prohibited.



Printed by Corlet Imprimeur, Imprim'vert® certified, a mark of its commitment to reducing the impact of its business activity on the natural environment.  
 This catalogue is printed on paper sourced from sustainably managed forests.



Specific decoration | Canada 2009



**GROUPE LCX®**  
— Expert in Lighting —

Groupe LCX®

**EXPORT DEPARTMENT**

6-8 rue Michaël Faraday | 72027 Le Mans Cedex 2 | France  
Ph. +33 (0)2 43 61 43 60 - Fax. +33 (0)2 43 61 43 75  
e-mail : [lcxexport@lcx.fr](mailto:lcxexport@lcx.fr)

INFORMATION & ORDER



INFORMATION & ORDER



French designer & manufacturer  
of luminous decorations since **1958**



Réf. 020269

**GROUPE LCX**<sup>®</sup>  
— Expert in Lighting —

Distributed in :

UK

**Gala Lights LTD**  
Ph +44 1622 882424  
info@galalights.com

Canada

**Leblanc Illuminations Canada**<sup>™</sup>  
Ph 1-866-814-3617  
gregoireginette@hotmail.com

Germany

**Leblanc**<sup>®</sup> **Illuminations GmbH**  
Ph +49 7771-916585-2  
info@ses-scherer.de

[www.lcx.fr](http://www.lcx.fr)